



Tempo de Montagem  
Assembly Time  
Tiempo de Ensamblaje

**ENTENDENDO OS CÓDIGOS CARIMBADO NAS PEÇAS:**  
UNDERSTANDING THE CODES STAMPED IN THE PARTS:  
**ENTENDIENDO LOS CÓDIGOS CARIBE EN LAS PIEZAS:**

000000 | 000 | 00

↓  
Número da peça  
Piece number  
Número de pieza

↓  
Número do lote  
Lot number  
Número de lote

↓  
Código do produto  
Product code  
Código del producto

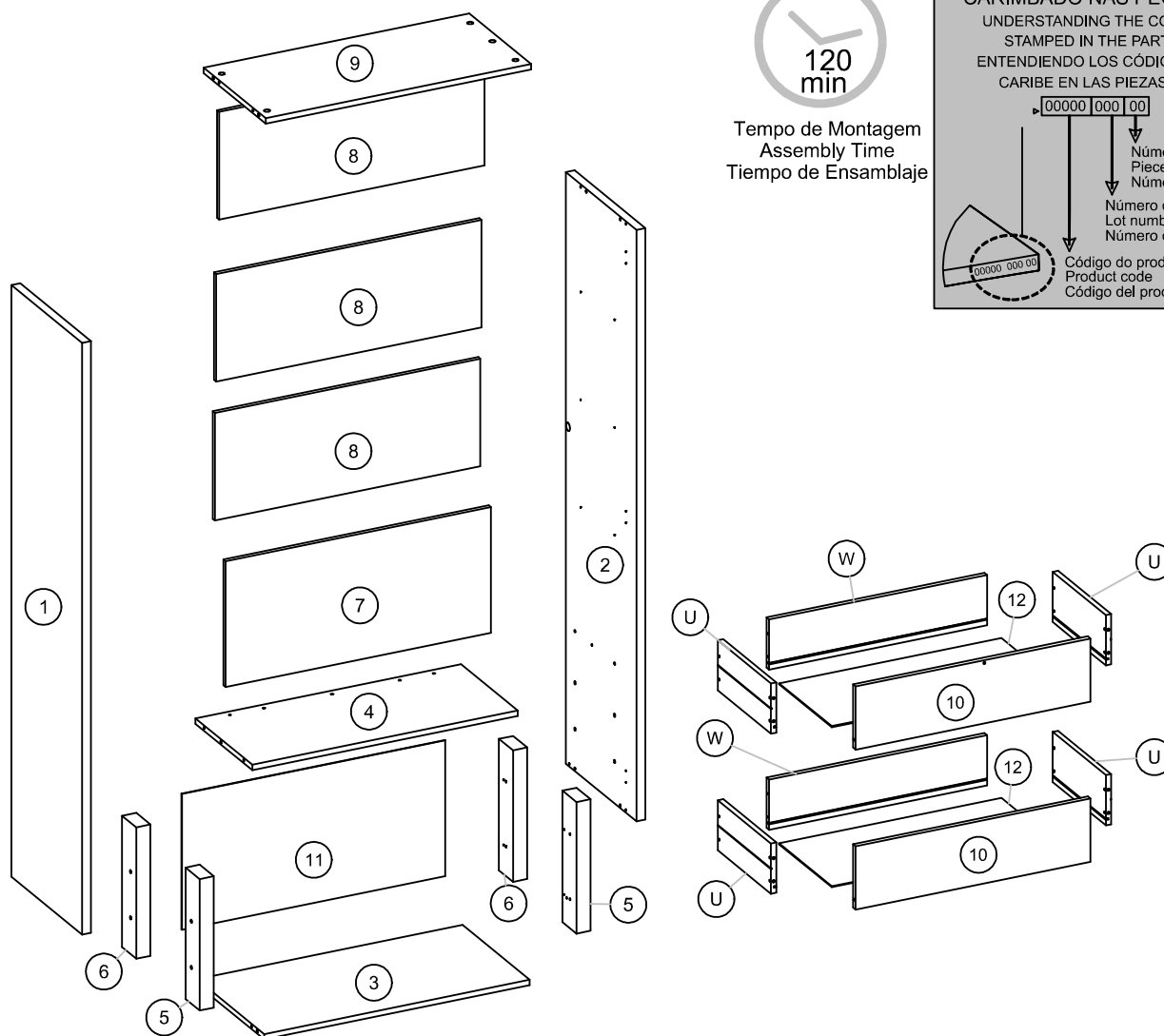

Nº	PEÇAS	PIECES	PIEZA	QTD
1	LATERAL ESQUERDA	LEFT SIDE	LADO IZQUIERDO	1
2	LATERAL DIREITA	RIGHT SIDE	LADO DERECHO	1
3	BASE	BASIS	BASE	1
4	TAMPO GAVETEIRO	DRAWER TOP	SUPERIOR DEL CAJÓN	1
5	DISTANCIADOR FRONTAL	FRONT DISTANCER	DISTANCIADOR DELANTERO	2
6	DISTANCIADOR TRASEIRO	REAR DISTANCER	DISTANCIADOR TRASERO	2
7	FUNDO MAIOR	BIGGER FUND	FONDO MÁS GRANDE	1
8	FUNDO MENOR	SMALLER BOTTOM	FONDO MÁS PEQUEÑO	3
9	TAMPO	COVER	CUBRIR	1
10	FRENTE DA GAVETA	DRAWER FRONT	FRENTE DEL CAJÓN	2
11	FUNDO	BOTTOM	ABAJO	1
12	FUNDO DA GAVETA	DRAWER BOTTOM	FONDO DEL CAJÓN	2
U	LATERAL DIR. E ESQ. DA GAVETA	RIGHT SIDE. AND LEFT. FROM THE DRAWER	LADO DERECHO. E IZQUIERDA. DEL CAJÓN	4
W	CONTRA FUNDO DA GAVETA	AGAINST DRAWER BOTTOM	CONTRA EL FONDO DEL CAJÓN	2



Ao solicitar assistência, informe número da peça e código do acessório  
When requesting assistance, tell the part number and serial number of accessory  
Al solicitar asistencia, informe el número de pieza y número de serie del accesorio



Atualizado em:  
CDIP-009-34491  
Revisão - 00



## 01°

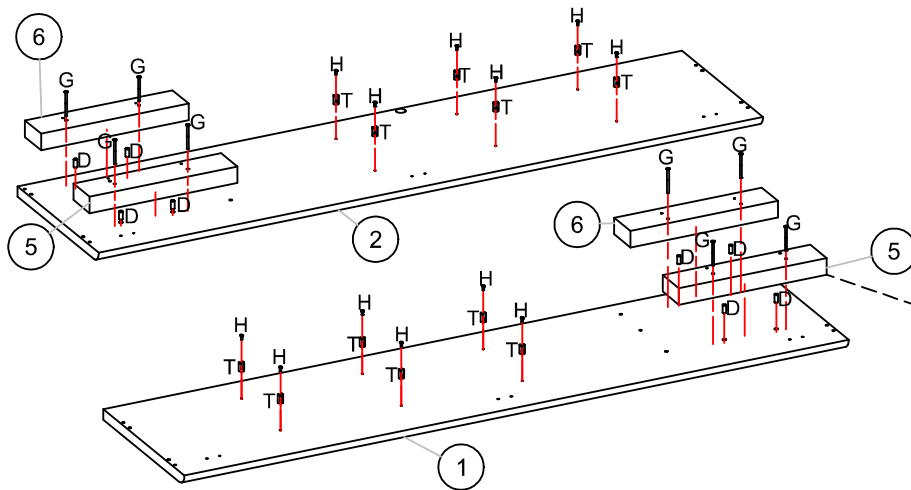
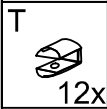
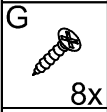
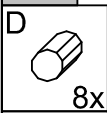

INSERIR PARAFUSO [G]  
NO PRIMEIRO FURO  
EM RELAÇÃO A FRENTE  
NOS DISTANCIADORES [5] E [6]  
INSERT SCREW [G]  
IN THE FIRST HOLE  
REGARDING THE FRONT  
IN DISTANCERS [5] AND [6]  
INSERTAR EL TORNILLO [G]  
EN EL PRIMER HOYO  
CON RESPECTO AL FRENTE  
EN DISTANCIADORES [5] Y [6]

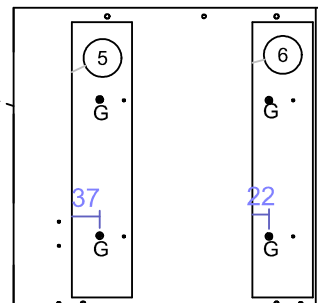

## 02°

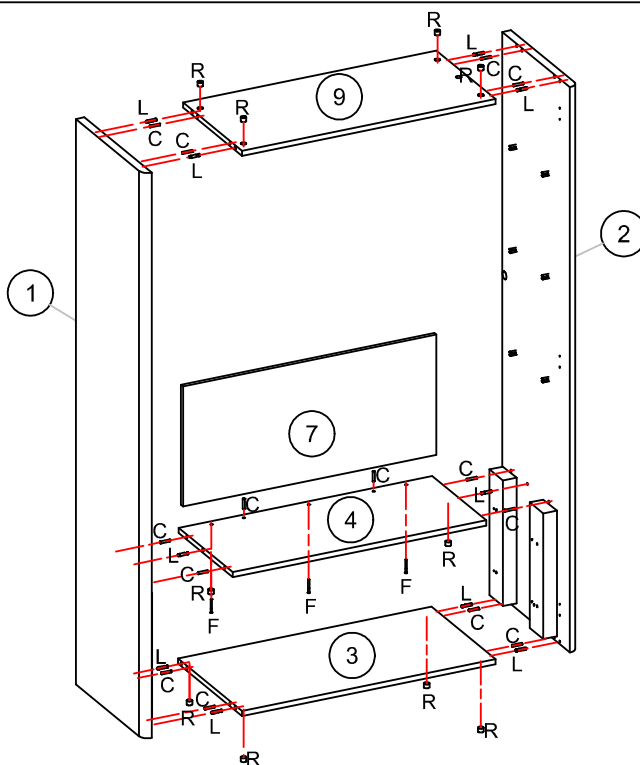
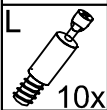
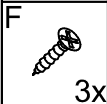
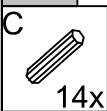

## 03°

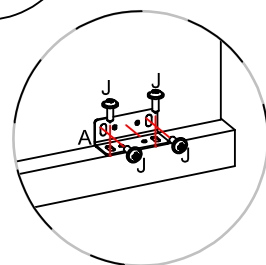
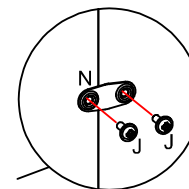
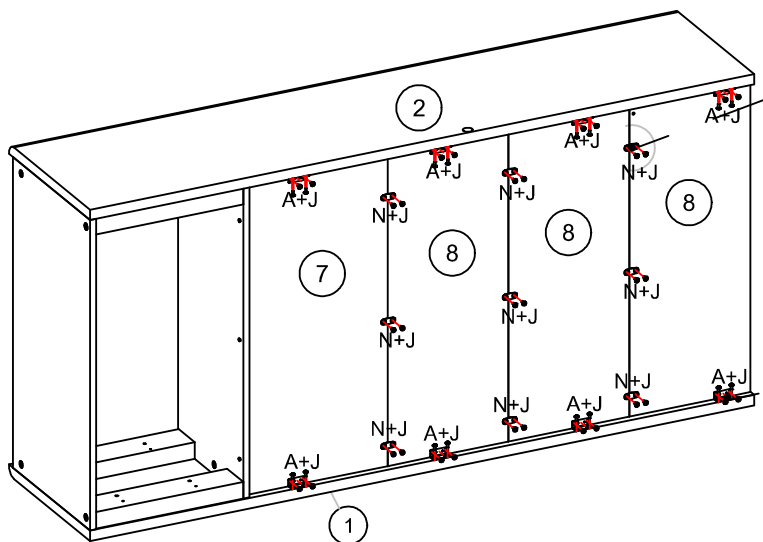
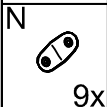
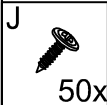
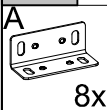

CANTONEIRA DEVE  
FICAR RENTE À LATERAL  
CORNER MUST  
STAY FLAT TO THE SIDE  
LA ESQUINA DEBE  
MANTÉNGASE PLANO HACIA  
UN LADO

04°

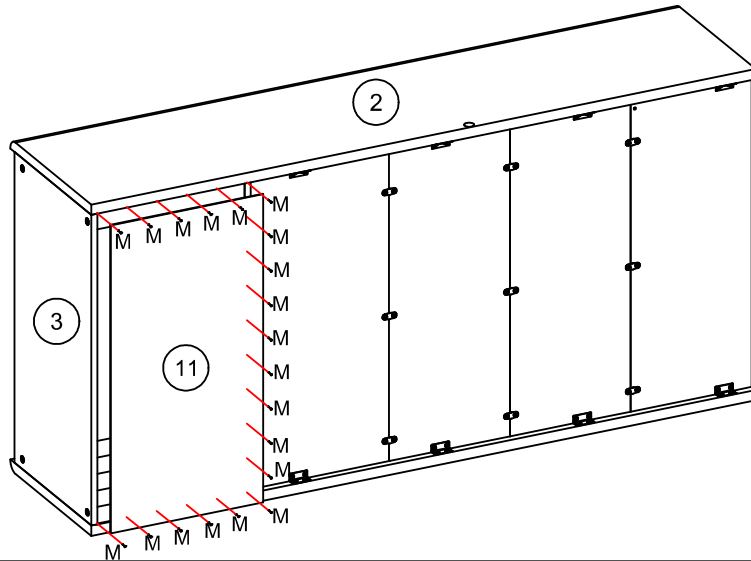

05°

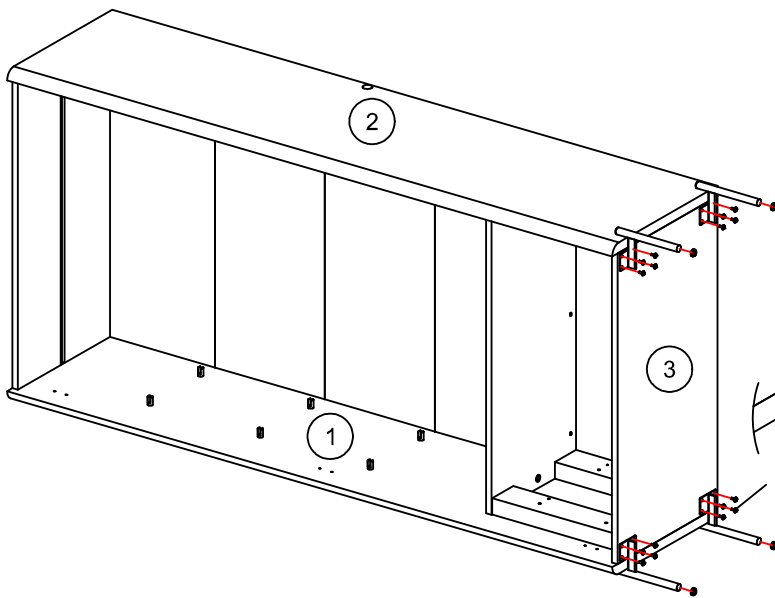
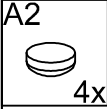
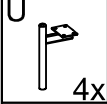
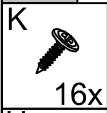



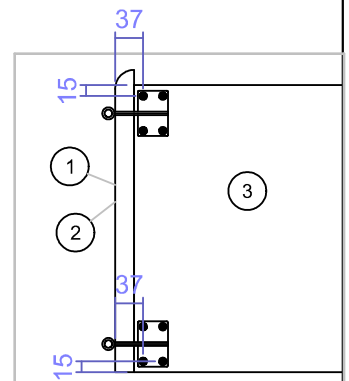



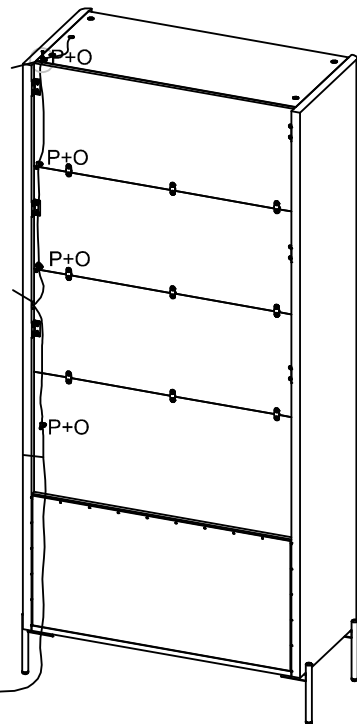
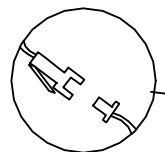
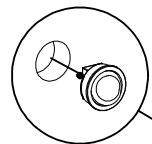
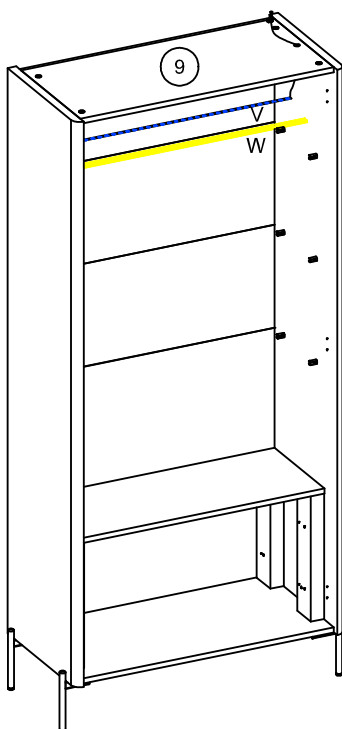
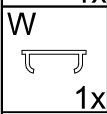
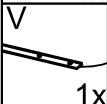
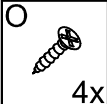
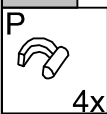

CONSIDERAR MEDIDAS PARA FIXAÇÃO DOS PÉS ( U )  
 CONSIDER MEASURES TO FIX THE FEET ( U )  
 CONSIDERAR MEDIDAS PARA FIJAR LOS PIES ( U )



06°



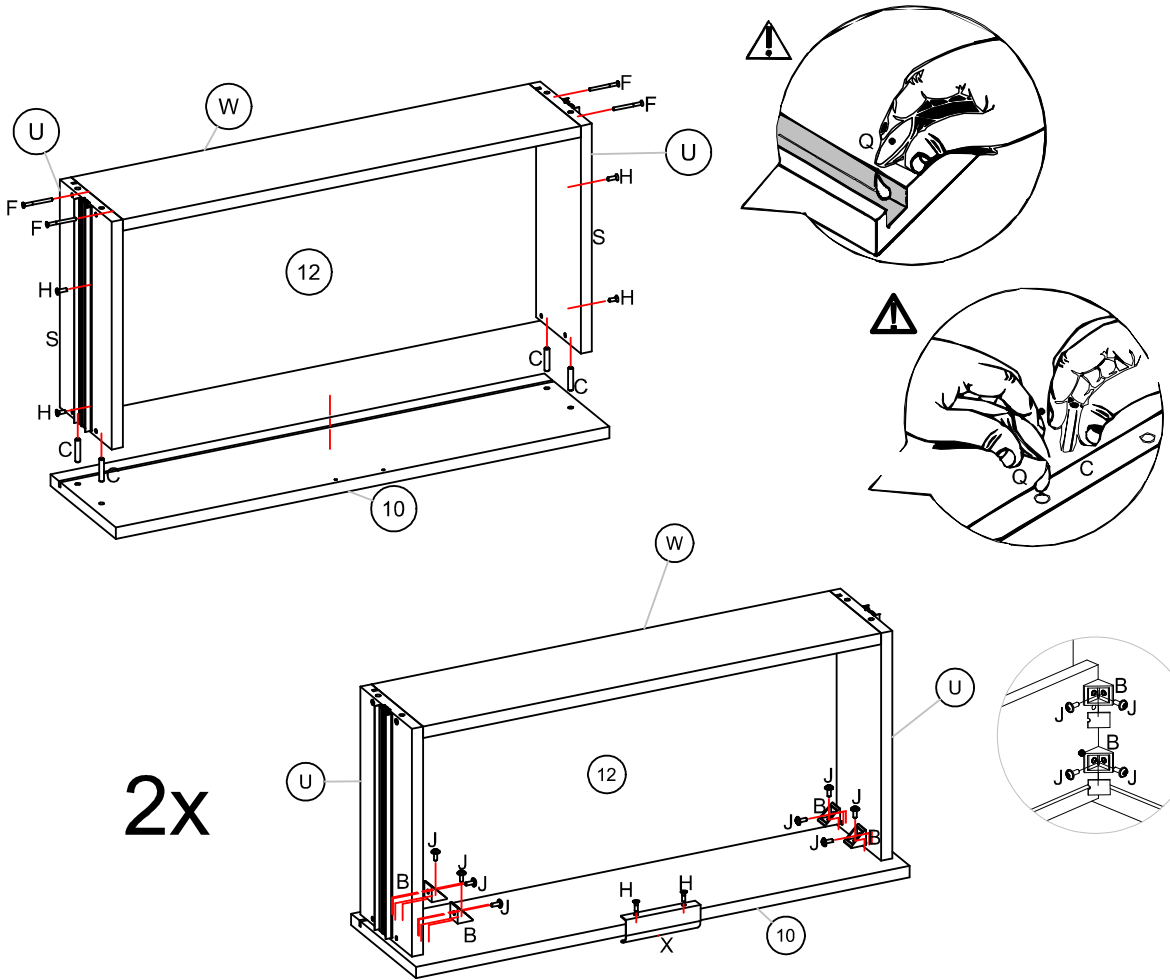

07°

- F  8x
- C  8x
- S  2x
- H  12x
- B  8x
- J  16x
- Q  2x
- X  2x



08°

- S  2x
- I  8x
- Y  3x

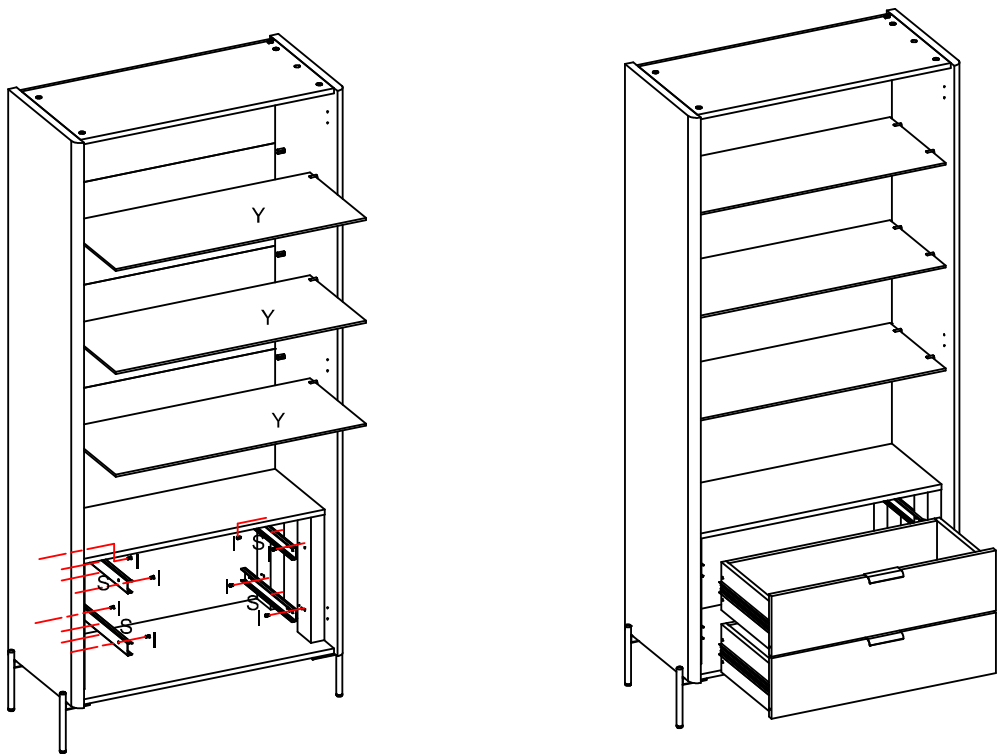

09°

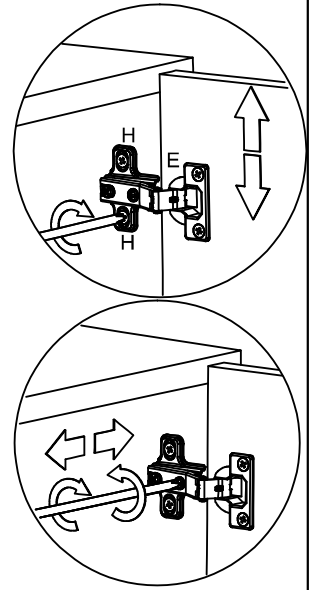
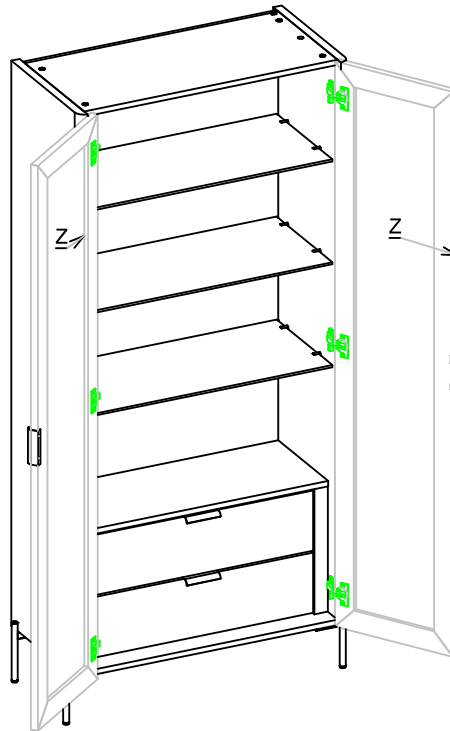
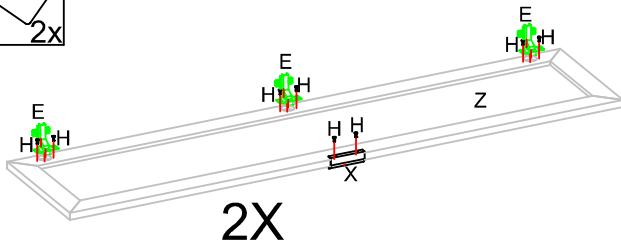
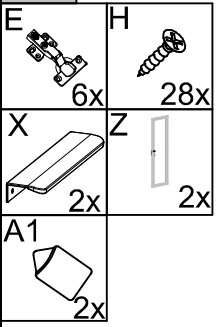

ASPECTO FINAL / Final Aspect

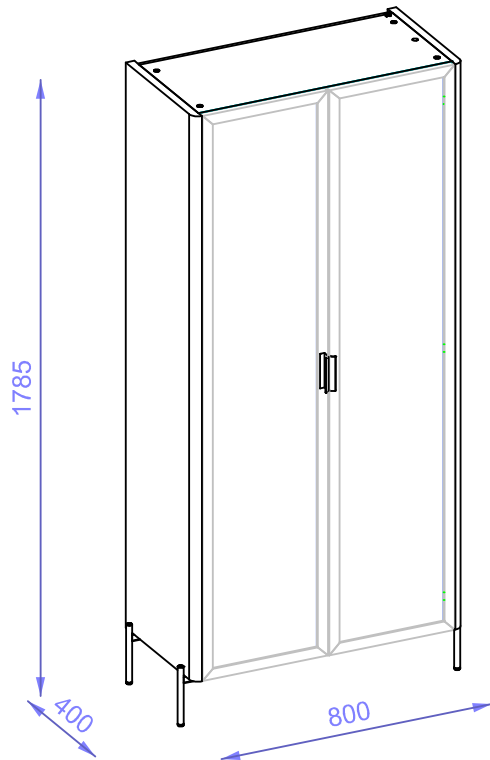
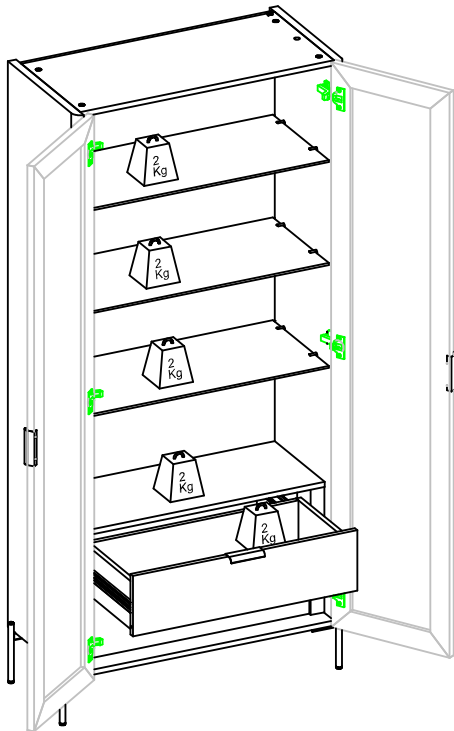

Instruções para a montagem do produto:

Instructions for mounting the product:  
Instrucciones para el montaje del producto:



Separar as peças e acessórios de maneira organizada.  
Separate the parts and accessories in an organized way.  
Separar las piezas y accesorios de forma organizada

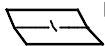

Forrar o chão com o papelão das embalagens.  
Cover the floor with the cardboard from the pack.  
Cubrir el suelo con el papelón de los embalajes.



É necessário uma pessoa para montar o produto.  
It's necessary one person to assemble the product.  
Se requiere una persona para montar el producto.

Ferramentas necessárias (não fornecidas)  
Required tools (not supplied)  
Herramientas necesarias (no incluidas)



Cuidados para conservação e limpeza do móvel:

Cleaning and care of furniture:  
Cuidados para la conservación y la limpieza del mueble:



Não molhar o móvel e não expor em lugar úmido.  
Do not moisten the furniture and not to expose in moist places.  
No moje el mueble y no ponga en local húmedo.



Não expor o móvel próximo de fontes de calor.  
Do not expose furniture next to heat sources.  
No exponga el mueble cerca de fuentes emitan calor.



Não usar produtos abrasivos.  
Do not use abrasive products.  
No utilice productos abrasivos.



Limpe com flanela limpa e seca.  
For cleaning use a clean and dry cloth.  
Limpe con franela limpia e seca.

## Certificado de Garantia

90

DIAS

### PARABÉNS! VOCÊ ACABA DE ADQUIRIR UM PRODUTO COM A QUALIDADE DJ MOVEIS

Siga as instruções de montagem e de conservação constantes neste manual. A montagem deve ser realizada por um profissional especializado. Forre o chão com o papelão da embalagem, evitando possíveis riscos ao produto. Utilizar ferramentas adequadas: chave de fenda, philips, martelo de borracha. Obs. Cuidado especial ao apertar os parafusos com parafusadeira. Na limpeza, utilize flanela seca ou úmida. Não utilize produto de origem química tais como: álcool, removedores, polidor ou qualquer produto abrasivo (eles podem reagir com o verniz do produto e danificá-lo). Não exponha o produto diretamente à luz do sol. Não coloque o produto em paredes ou pisos que contenham umidade ou estejam irregulares.

CLIENTE: \_\_\_\_\_

NOTA FISCAL: \_\_\_\_\_

Esta garantia não cobre defeitos por mau uso, montagem inadequada, utilização de produtos de limpeza não especificados nesse certificado e excesso de peso.

SR. MONTADOR, este CERTIFICADO é de uso exclusivo do CONSUMIDOR, favor entregá-lo ao mesmo.

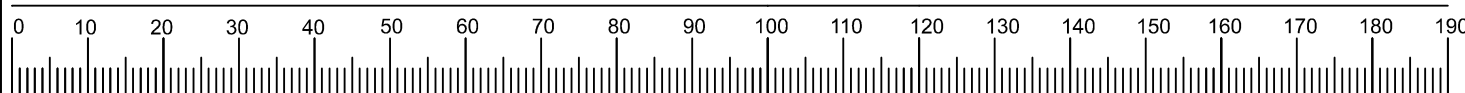

COD.	ACESSÓRIOS	ACCESSORIES	ACCESSORIOS	QT.
A	CANTONEIRA 17,5x17,5x46	CORNER BOARD 17.5x17.5x44	TABLERO ESQUINERO 17,5x17,5x44	8
B	CANTONEIRA COM CAPA	CORNER BOWL WITH COVER	CUENCO DE ESQUINA CON TAPA	8
C	CAVILHA 6X30MM	DOWEL 6X30MM	CLAVIJA 6X30MM	22
D	CAVILHA 8X20MM	DOWEL 8X20MM	CLAVIJA 8X20MM	8
E	DOBRADICA SUPER ALTA 35MM COM AMORTECEDOR	SUPER HIGH HINGE 35MM WITH SHOCK ABSORBER	BISAGRA SUPER ALTA 35MM CON AMORTIGUADOR	6
F	PARAFUSO 3.5 X 40 CABECA CHATA	SCREW 3.5 X 40 FLAT HEAD	TORNILLO 3.5 X 40 CABEZA PLANA	11
G	PARAFUSO 4.5 X 60 CABECA CHATA	SCREW 4.5 X 60 FLAT HEAD	TORNILLO 4.5 X 60 CABEZA PLANA	8
H	PARAFUSO 4 X 14 CABECA CHATA	SCREW 4 X 14 FLAT HEAD	TORNILLO 4 X 14 CABEZA PLANA	52
I	PARAFUSO 6.0 X 10 CABECA CHATA 7,3	SCREW 6.0 X 10 FLAT HEAD 7.3	TORNILLO 6.0 X 10 CABEZA PLANA 7.3	8
J	PARAFUSO 4X12MM CABECA FLANGEADA	SCREW 4X12MM FLANGE HEAD	TORNILLO 4X12MM CABEZA BRIDA	66
K	PARAFUSO 4X16MM CABECA FLANGEADA	SCREW 4X16MM FLANGE HEAD	TORNILLO 4X16MM CABEZA BRIDA	16
L	PARAFUSO MINIFIX LIGHT	MINIFIX LITE SCREW	TORNILLO MINIFIX LITE	10
M	PREGO 10X10 COM CABECA	10X10 NAIL WITH HEAD	CLAVO 10X10 CON CABEZA	20
N	SUPORTE FIXACAO 35X15MM	FIXING SUPPORT 35X15MM	SOPORTE FIJACION 35X15MM	9
O	PARAFUSO 3 X 16 CABECA CHATA	SCREW 3 X 16 FLAT HEAD	TORNILLO 3 X 16 CABEZA PLANA	4
P	SUPORTE COAXIAL SEM PREGO	NAIL-FREE COAXIAL SUPPORT	SOPORTE COAXIAL SIN CLAVOS	4
Q	SACHE DE COLA	GLUE SACHET	BOLSA DE PEGAMENTO	2
R	TAMBOR MINIFIX 15MM	MINIFIX DRUM 15MM	TAMBOR MINIFIX 15MM	10
S	CORREDIÇA TELESCÓPICA LIGHT 300 x 30mm	LIGHT TELESCOPIC SLIDE 300 x 30mm	DIAPPOSITIVA TELESCÓPICA LIGERA 300 x 30mm	2
T	SUPORTE VIDRO 6MM S/ PINO	6MM GLASS SUPPORT WITHOUT PIN	SOPORTE VIDRIO 6MM SIN PASADOR	12
U	PE METALICO LATERAL 145MM TUBO 16MM DOURADO	SIDE METALLIC PE 145MM TUBE 16MM GOLDEN	LATERAL METALICO PE 145MM TUBO 16MM DORADO	4
V	KIT FITA LED 700MM COM CHAVE PRETA	700MM LED STRIP KIT WITH BLACK KEY	KIT TIRA LED 700MM CON LLAVE NEGRA	1
X	PUXADOR FLORENCA 100MM DOURADO	FLORENCE HANDLE 100MM GOLDEN	MANGO FLORENCIA 100MM DORADO	4
W	LENTE PARA FITA LED CHANFRADA 750mm	LENS FOR CHAMFERED LED STRIP 750mm	LENTE PARA TIRA LED BISELADA 750mm	1
Y	PRATELEIRA DE VIDRO 740x330x6MM	GLASS SHELF 740x330x6MM	ESTANTE CRISTAL 740x330x6MM	3
Z	PORTA VIDRO REFLECTA BRONZE - OFF WHITE	BRONZE REFLECT GLASS HOLDER - OFF WHITE	SOPORTE DE VIDRIO REFLECTANTE DE BRONCE - BLANCO ROJO	2
A1	GIZ DE CORREÇÃO 15X8MM	CORRECTION CHALK 15X8MM	TIZA CORRECTORA 15X8MM	2
A2	SAPATA PLASTICA	PLASTIC SHOE 16mm	ZAPATO PLÁSTICO 16mm	4